

# Thermostatic regulator for domestic hot water recirculation circuits



01139/06 GB

## 116 series



cert. n° 0003  
ISO 9001



### Function

The thermostatic regulator is used for automatic balancing of recirculation circuits in domestic hot water distribution systems, so as to ensure that all parts of the network reach the required temperature.

It is also equipped with a by-pass mechanism, either manual or automatic with thermoelectric actuator, to be used in the event of thermal disinfection against Legionella.

### Product range

|             |  |                  |
|-------------|--|------------------|
| 116 series  | Thermostatic regulator for recirculation circuit | size 1/2" - 3/4" |
| Code 116002 | Thermoelectric actuator for 116 series           | 230 V (ac)       |
| Code 116004 | Thermoelectric actuator for 116 series           | 24 V (ac)        |

### Technical specifications

|                   |                         |                       |
|-------------------|-------------------------|-----------------------|
| <b>Materials:</b> | - body:                 | brass EN 12165 CW617N |
|                   | - adjustable cartridge: | PPS                   |
|                   | - springs:              | stainless steel       |
|                   | - hydraulic seals:      | EPDM                  |

### Performance:

|                             |         |
|-----------------------------|---------|
| Medium:                     | water   |
| Temperature setting range:  | 35–65°C |
| Factory set:                | 55°C    |
| Accuracy:                   | ± 2°C   |
| Max. working temperature:   | 100°C   |
| Max. working pressure:      | 10 bar  |
| Max. pressure differential: | 1 bar   |

Connections: 1/2"–3/4" F

Pressure port connections: 1/4" F with plug

### Thermoelectric actuator

|                            |                        |
|----------------------------|------------------------|
| Normally closed-ON/OFF     |                        |
| Electric supply:           | 230 V (ac) – 24 V (ac) |
| Power consumption:         | 1,8 W                  |
| Insulation:                | class II               |
| Protection class:          | IP 54                  |
| Ambient temperature range: | 0–60°C                 |
| Operating time:            | 150–200 s              |
| Length of supply cable:    | 1 m                    |

### Dimensions

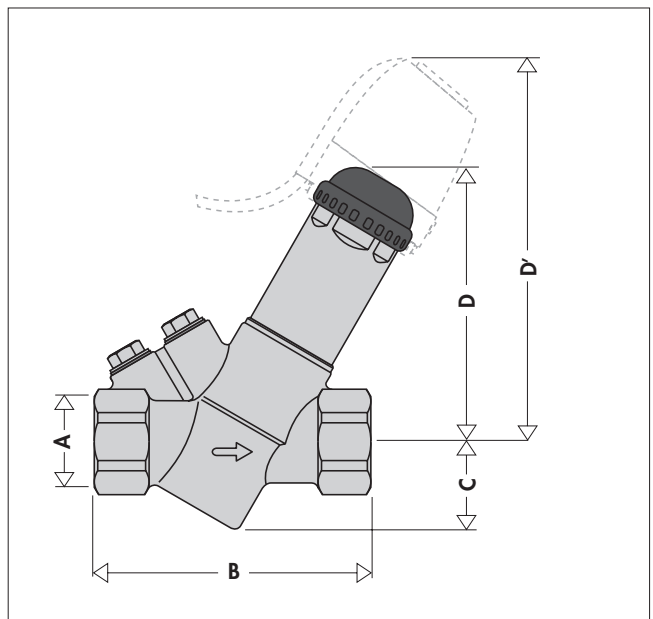

| Code   | A    | B  | C  | D  | D'  | Weight (kg) |
|--------|------|----|----|----|-----|-------------|
| 116040 | 1/2" | 80 | 31 | 97 | 132 | 0,61        |
| 116050 | 3/4" | 80 | 31 | 97 | 132 | 0,56        |

## Operating principle

On reaching the set temperature, the obturator, governed by an internal thermostat, modulates the closure of the hot water orifice, thereby aiding circulation towards the other connected circuits. If the temperature decreases there is the opposite action and the orifice reopens.

Thanks to the special design of the preassembled cartridge, the thermostat is not directly in contact with the hot water in circulation. This limits potential trouble with blockage due to limescale.

The regulator is equipped with a mechanism that allows circulation regardless of the thermostat action, used to carry out thermal disinfection of the circuit.

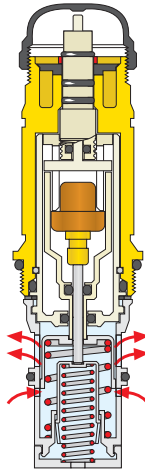

## Hydraulic characteristics

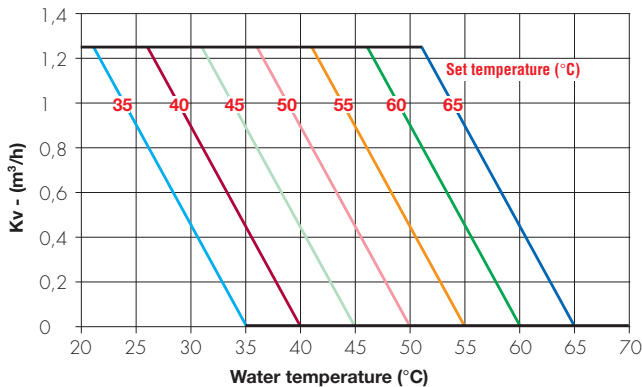

## System sizing

The thermostatic regulators are used for automatic balancing of the various branches of domestic hot water recirculation circuits, so as to ensure the required temperature in each section, to prevent the growth of Legionella and limit heat losses.

The recirculation circuits are generally sized according to the flow rate required for each branch, based on the allowed heat loss and the corresponding decrease in temperature along the pipe. Generally speaking, the maximum allowed temperature drop between the point of departure from the heating plant and the point of return to the latter is 5°C.

According to the flow rate, determined using the various calculation methods, it is possible to calculate the loss of head caused by passage through the thermostatic regulator, using the graphs provided below.

The curves for the loss of head are shown with:

- valve in thermostatic operating mode. In this case, reference is made to an average aperture corresponding to 5K, between the valve set temperature and the incoming water temperature, bearing in mind the losses along the pipe. This value allows the head required for the recirculation pump to be limited. **It is also always necessary to take care to ensure the minimum flow rate required by the mixers in the heating plant.**
- valve in by-pass operating mode. In this case, the valve obturator is fully open and the minimum loss of head is produced during thermal disinfection against Legionella.

## Graph for head loss

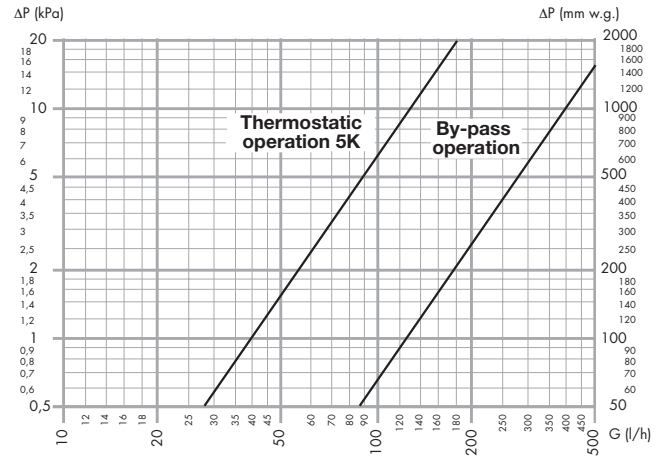

To correctly size the recirculation pump head, add the loss of head of the valve to the loss of head of the most disadvantaged circuit.

## Example

Recirculation circuit calculated for an average heat loss of 12 W/m and a temperature difference of 2K between the starting point and the most unfavourable delivery point, at the top of a riser 20 m. in height. Thermostatic regulator located at the base of the riser.

Flow rate for the riser, which therefore passes through the thermostatic regulator:

$$G = 12 \cdot 20 \cdot 0,860/2 = 103 \text{ l/h}$$

Thermostatic regulator set temperature:

$$T_{\text{reg}} = 55^\circ\text{C}.$$

The graph shows the loss of head of the valve, in thermostatic operation:

$$\Delta p_{\text{reg}} = 6 \text{ kPa}.$$

From calculations made based on the nominal flow rates, the loss of head from the pipes in the circuit and from the circuit components such as boiler, mixer, valves of the most disadvantaged circuit can be found.

Let us suppose that this value is known:

$$\Delta p_{\text{circuit}} = 14 \text{ kPa}$$

Pump head at nominal flow rate:

$$H = \Delta p_{\text{circuit}} + \Delta p_{\text{reg}} = 14 + 6 = 20 \text{ kPa}.$$

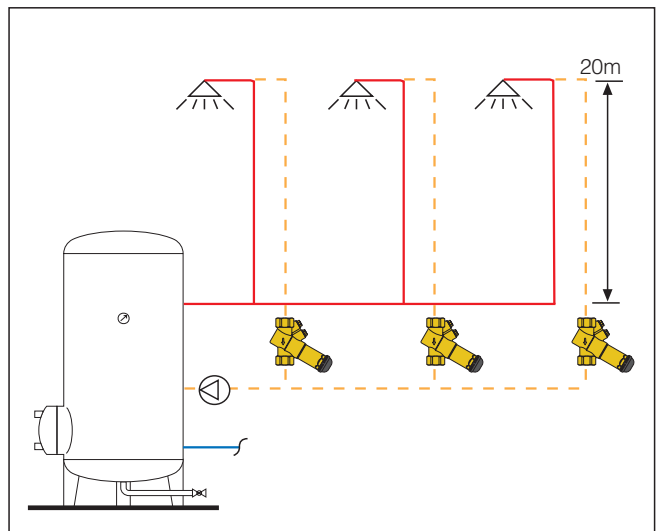

### Installation

Before fitting the thermostatic regulator, the pipes must be flushed to ensure that none of the impurities in circulation will affect its performance.

We recommend always installing filters of sufficient capacity at the inlet of the water system.

The thermostatic regulator can be fitted in any position, vertical or horizontal, provided it complies with the direction of flow indicated by the arrow on the valve body.

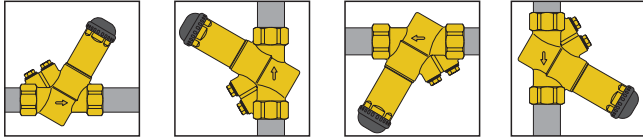

### Temperature setting

The regulator is supplied with a factory temperature setting of 55°C. The temperature is set at the desired value by turning the upper screw with the control key. The graded scale shows the temperatures to which the indicator can be set.

After adjustment, screw the black protective cover all the way down to activate thermostatic operation.



### Checking temperature

The valve body is fitted with threaded connectors, which can be used for pressure/temperature ports to check the temperature reached and the loss of head.

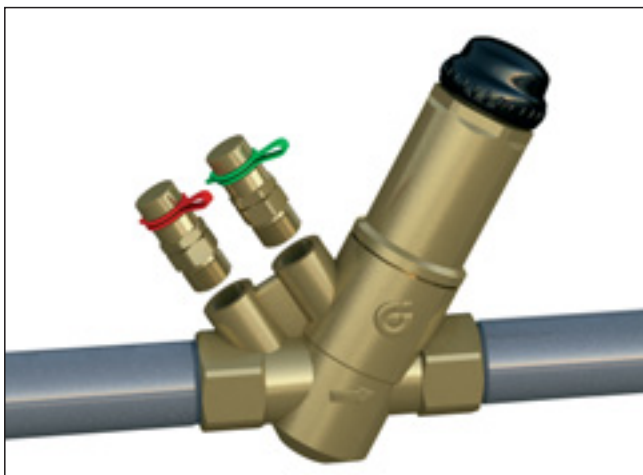

### By-pass

The by-pass mechanism operates manually, simply by removing the black protective cover.

By installing the thermoelectric actuator it is possible to govern the mechanism automatically.

To ensure that the valve is in the open position while the system is being put into service, the actuator is supplied in a normally open (NO) position, and remains in this position until it is powered up electrically for the first time.

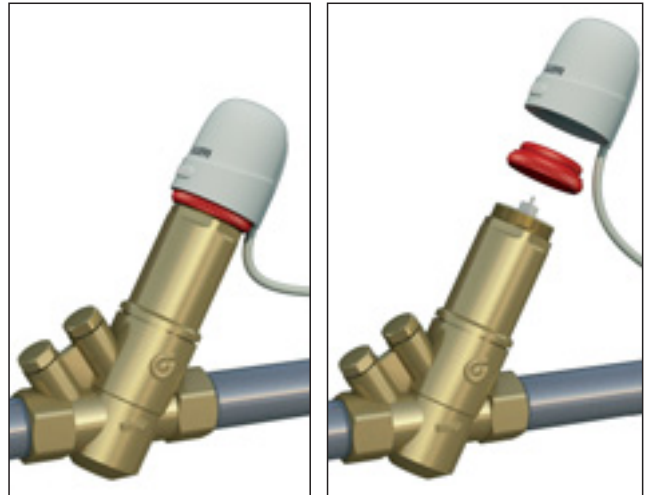

### Maintenance

The preassembled cartridge containing the control components can be removed from the valve body for checking, cleaning or replacement.

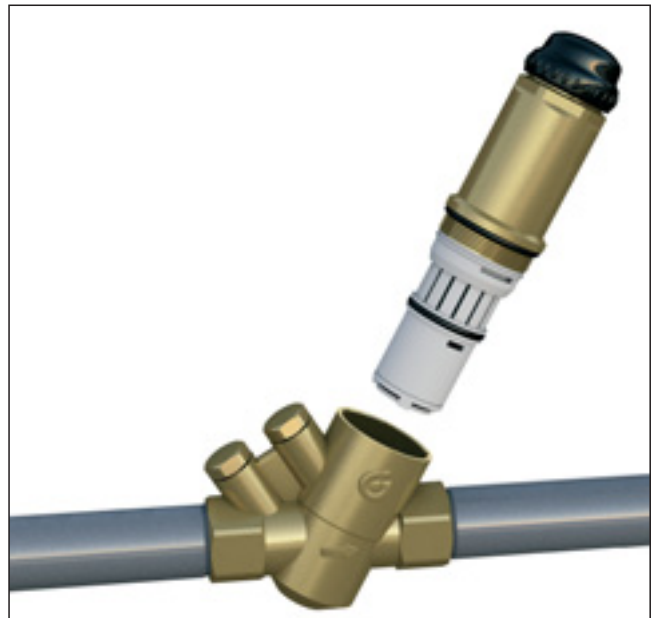

## Application diagrams

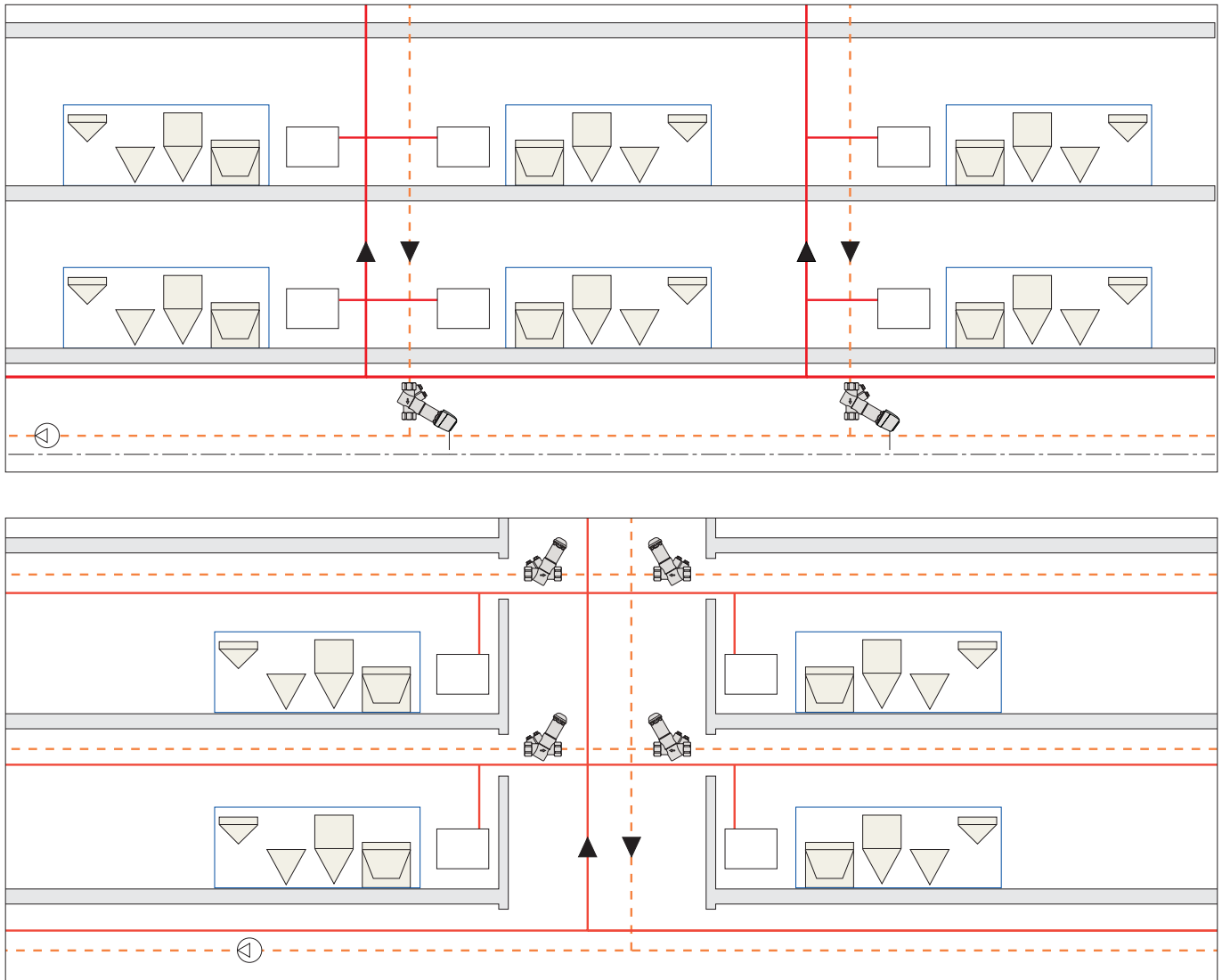

## SPECIFICATION SUMMARIES

### 116 series

Thermostatic regulator for domestic hot water recirculation circuits. Connections 1/2" and 3/4" F. Pressure port connections 1/4" F with plug. Brass body. Adjustable PPS cartridge. Stainless steel springs. EPDM hydraulic seals. Regulation temperature range 35–65°C. Factory setting 55°C. Precision  $\pm 2^\circ\text{C}$ . Maximum working temperature 100°C.

### Code 116002

Thermoelectric actuator for 116 series, normally closed-ON/OFF. Power supply 230 V (ac). Power consumption 1,8 W. Insulation class II. Protection class IP 54. Ambient temperature range 0–60°C. Operating time 150–200 s. Power cable length 1 m.

### Code 116004

Thermoelectric actuator for 116 series, normally closed-ON/OFF. Power supply 24 V (ac). Power consumption 1,8 W. Insulation class II. Protection class IP 54. Ambient temperature range 0–60°C. Operating time 150–200 s. Power cable length 1 m.

*We reserve the right to change our products and their relevant technical data contained in this publication at any time and without prior notice.*

